

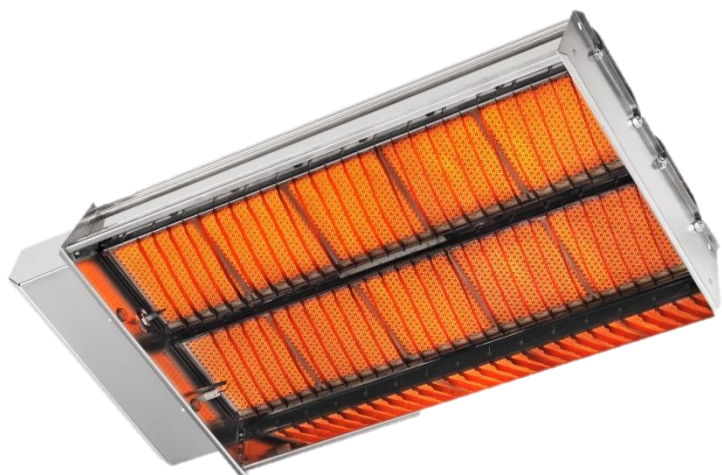

RADIANT LUMINEUX

SX



- ✓ Confort de chauffage optimum
- ✓ Durée de vie exceptionnelle
- ✓ Option double allure
- ✓ Installation simplifiée (pas de percement de l'enveloppe du bâtiment)
- ✓ Contrôle de flamme par thermocouple



FONCTIONNEMENT

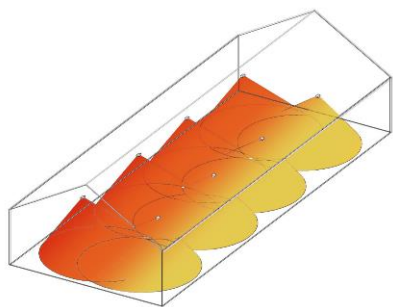

Le rayonnement infrarouge apporte le **confort** directement au niveau des utilisateurs générant ainsi des **économies d'énergie importantes**.

Efficace pour tout **bâtiment** d'une hauteur de **4 à 25 m**.

DIMENSIONS

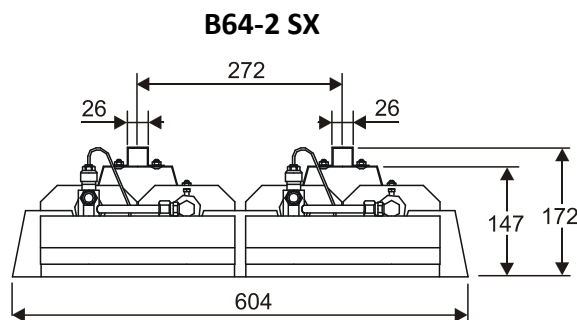
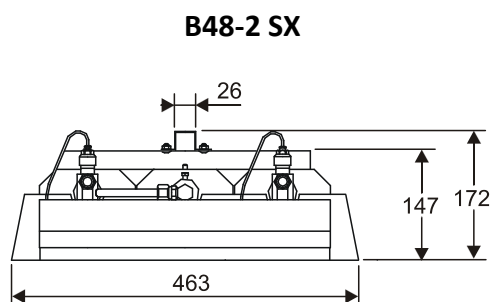
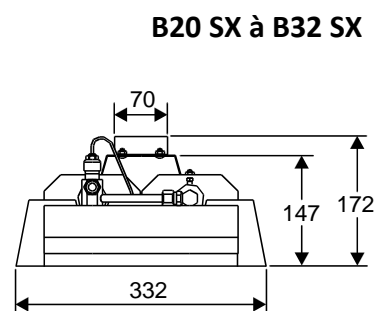
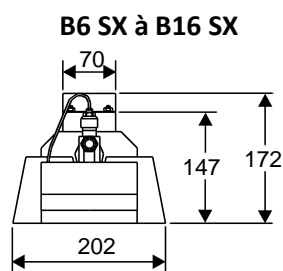
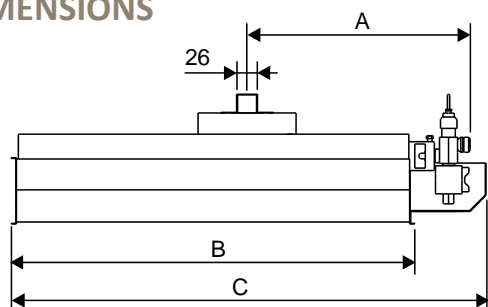

DONNÉES TECHNIQUES

MODÈLE	B6 SX	B8 SX	B10 SX	B12 SX	B16 SX	B20 SX B20-2 SX	B24 SX B24-2 SX	B32 SX B32-2 SX	B48-2 SX	B64-2 SX
Puissance nominale (kW)	2,8	3,7	4,2	5,7	7,5	8,4	11,3	15,0	22,5	30,0
GAZ										
Nombre de brûleurs	1	1	1	1	1	2	2	2	3	4
Conso gaz en G20-20mbar (m³/h)	0,27	0,35	0,40	0,54	0,72	0,81	1,08	1,43	2,15	2,86
Conso gaz en G25-25mbar (m³/h)	0,31	0,40	0,47	0,63	0,83	0,94	1,26	1,66	2,49	3,32
Conso gaz en G31-37mbar (kg/h)	0,20	0,26	0,30	0,40	0,53	0,60	0,80	1,06	1,59	2,11
Option double allure						✓	✓	✓	✓	✓
Raccord d'entrée gaz	Raccord G1/2" cylindrique (ISO 228-1)									
ÉLECTRICITÉ										
Alimentation électrique	230V (+10% - 15%) – 50Hz Neutre obligatoire									
Consommation électrique* (VA)	28	28	28	28	28	28 / 56	28 / 56	28 / 56	56	56
DIMENSIONS										
Poids (kg)	2,5	2,9	3,1	3,4	4,1	5,0	5,5	6,7	9,4	12,2
A (mm)	186	218	243	281	299	243	281	299	299	299
B (mm)	222	285	334	411	536	334	411	536	536	536
C (mm)	318	382	431	508	632	431	508	632	632	632

*Consommation électrique lors de l'allumage des radiants (45 secondes)

Numéro certificat **CE** : 1312 AP 230, 1312 AP 231, 1312 AP 232 et 1312 AP 249
Classe NOx : 4 (<100 mg/kWh)

